

Part number

# CX7MA 10

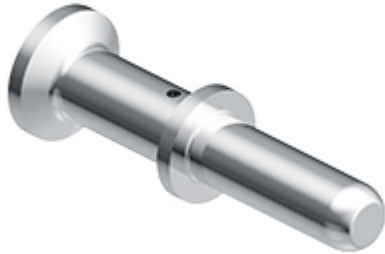

Male crimp contact, CX7 series, 70 A, turned silver plated, wire cross section 10 mm<sup>2</sup>, AWG 8 - 7

Product description		Material properties	
<b>Product type</b>	Crimp contact	<b>Main material</b>	Copper alloy
<b>Series</b>	CX7		Compliant with exemption 6(c): copper alloy containing up to 4% lead by weight
<b>Gender</b>	Male	<b>RoHs conformity</b>	6(c): copper alloy containing up to 4% lead by weight
Technical data		<b>China RoHs - EFUP</b>	50
<b>Current</b>	70 A	<b>REACH SVHC substances</b>	Yes
<b>Wire cross-section</b>	10,00 mm <sup>2</sup>		Lead
<b>AWG size</b>	8 - 7	<b>SCIP number</b>	C0979fba-9907-458f-a94a-db781440f273
<b>Contact type</b>	Turned silver plated	Approvals / Standards	
Further technical details		<b>Certifications</b>	CSA, EAC
<b>Mating cycles</b>	≥ 500	<b>UL</b>	ECBT2
<b>Contact resistance</b>	≤ 0,5 mΩ	<b>cUL</b>	ECBT8
<b>Weight</b>	10,00 g	General ordering information	
<b>Operating temperature range (min, max)</b>	-40°C ... +125°C	<b>EAN13 code</b>	8015747182461
<b>Conductors stripping length</b>	15 mm	<b>eCl@ss 8.1</b>	27440204
		<b>ETIM 7.0</b>	EC000796
		Packaging Information	
		<b>Sub-packaging length</b>	50,00 mm
		<b>Sub-packaging height</b>	44,00 mm
		<b>Sub-packaging width</b>	50,00 mm
		<b>Sub-packaging weight</b>	0,16 kg
		<b>Sub-packaging volume</b>	0,11 dm <sup>3</sup>
		<b>Sub-packaging description</b>	Plastic box
		<b>Sub-packaging quantity</b>	16 Pcs
		<b>Sub-packaging EAN barcode</b>	8015747182560

Part number

# CX7MA 10



Catalogue drawings

PART NUMBERS SILVER PLATED	øA mm	B mm	WIRE GAUGE		STRIPPING LENGTH mm
			mm <sup>2</sup>	AWG	
CX7MA 6.0	3,5	36	6	10	15
CX7MA 10	4,3	35,2	10	7	
CX7MA 16	5,5	35,2	16	5	
CX7MA 16 XF	6,1	35,2	16	3	
CX7MA 25	7,0	35,2	25	3	

Catalogue drawings

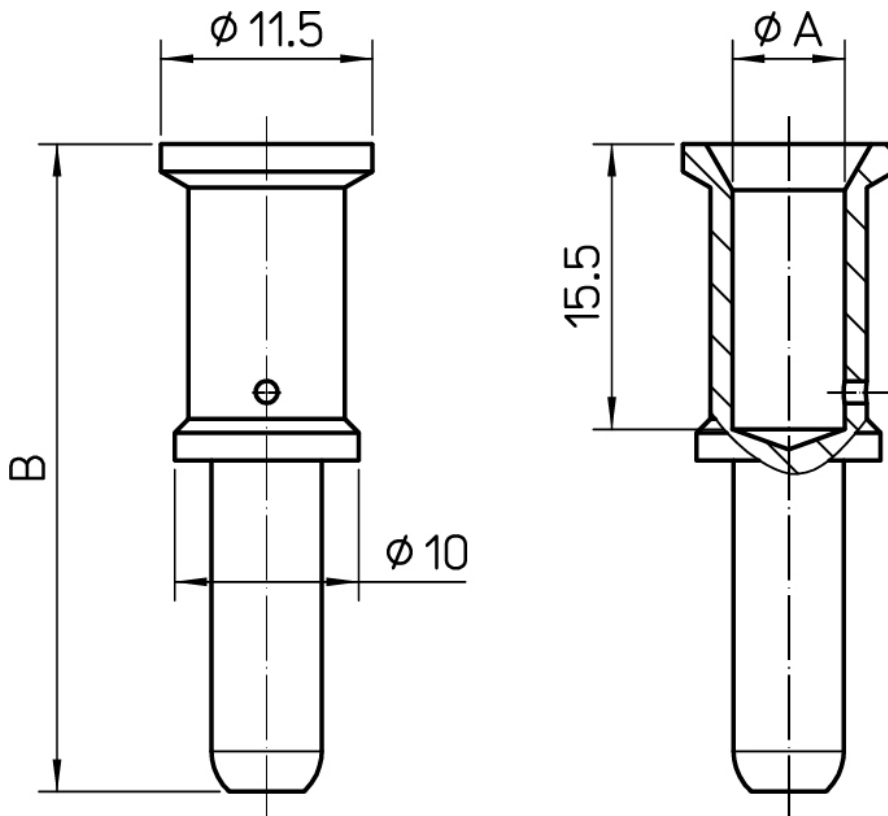

## Notes

Dimensions shown in mm are not binding and may be changed without notice.

## California Proposition 65 Information



### WARNING

This product can expose you to lead and its compounds, known to the State of California to cause cancer and/or reproductive toxicity. For more information go to [www.P65Warnings.ca.gov](http://www.P65Warnings.ca.gov).

---

With CXC inserts, nominal current is up to 80 A, according to the current derating diagram.

---